

SPARE PARTS

1200 Pivot EU







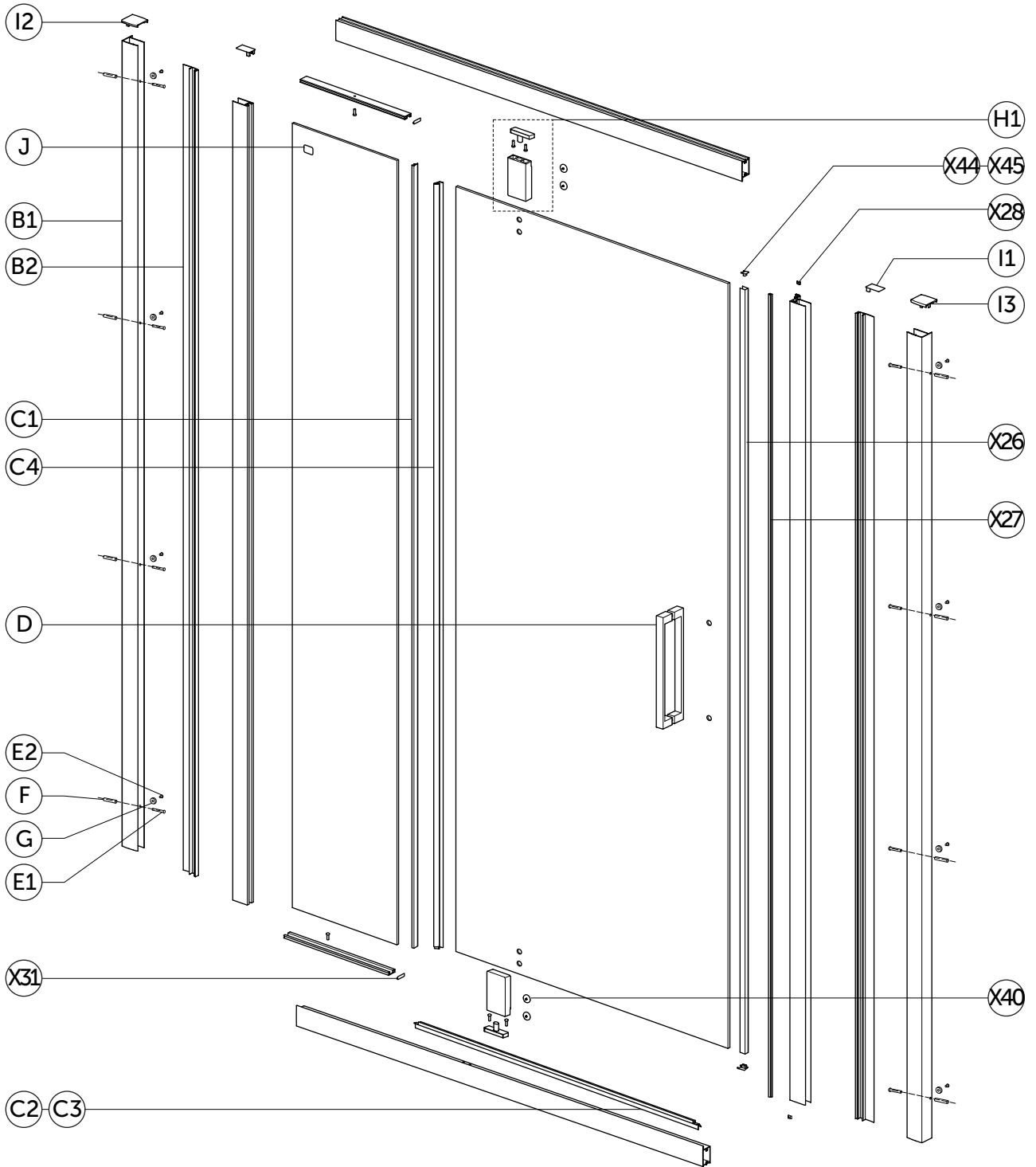

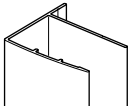
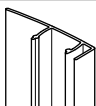

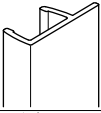
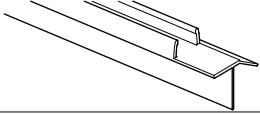
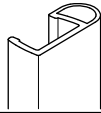

I.LIFE

T4939

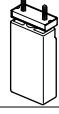

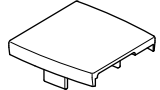
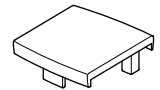

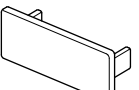

120

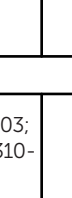
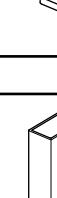

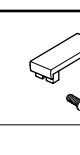
Item	ERP Code	Drawing	Description	Remark	SKU
B1	220659		Wall profile (EU - 20mm Adjustment)	length 2000mm, with 8 holes pre-drilled	TR001EO
B2	220660		Wall cover profile (EU - 20mm Adjustment)	length 2000mm	TR005EO

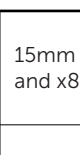
Item	ERP Code	Drawing	Description	Remark	SKU
C1	308-367		Vertical Panel anti-water seal	length 1914mm	TR07367
C2 C3	308-621		Bottom Flap seal 1200 - EU (Pair)	with 14mm & 6mm notch on each end LH & RH Seal length 790mm	TR15567
C4	308-611		Vertical Door anti-water seal	length 1899mm	TR08767
D	LY-MB810-116		Double Handle - 380mm centres	complete set	TR098AA
E1			Installation pack fixing wall jamb on wall	TCB 3.9X30 : x8pcs	TR03667
E2				TCB 3.9X9 : x8pcs	
F				wall plug: x8pcs	
G		LY-JC200-10			
H1			Pivot with covers and installation screws		TR128AA
I1	LY-MB810-90		cover for vertical profile (EU - 20mm Adjustment)		TR105AA
I2	LY-MB810-91L		Top cover for wall profile LH (EU - 20mm Adjustment)	Top cover for wall profile LH x1	TR106AA
I3	LY-MB810-91R		Top cover for wall profile RH (EU - 20mm Adjustment)	Top cover for wall profile RH x1	TR107AA
J			S.S. sticker with positioning template		KV29567
X26	LY-MB615-20		Magnetic sealer	magnet sealer 1896mm: x1pc	TR065AH
X27	LY-MB615-20		Pivot Frame Magnet Seal	magnet sealer 1990mm: x1pc	TR03467
X28	LY-MB615-13		Stopper for the magnetic seal on fixing profile side (pair)		TR069AH
X31	LY-MB810-86		Panel Retainer Pack	1pc only	TR130AA

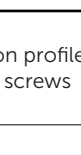
Item	ERP Code	Drawing	Description	Remark	SKU
X40	LY-MB815-07		Flush Cover Cap for Hinges & Pivots		TR159AA
X44	LY-MB810-83		Magnetic seal 2 top covers (pair)		TR120AA
X45	LY-MB810-83		Magnetic seal 2 top covers (pair)		

X8	2258003; LY-JC310-51		15mm Extension profile, cover cap and x8 ST4x10 screws	holes pre-drilled	T4893EO
X11	LY-JC310-51		15mm Extension profile cover cap		TR111AA
X9	220651; LY-MB810-82		20mm Extension profile, cover cap and x8 ST4x10 screws	holes pre-drilled	T4894EO
X12	LY-MB810-82		20mm Extension profile cover cap		TR112AA
X10	220650; LY-MB810-81		25mm Extension profile, cover cap and x8 ST4x10 screws	holes pre-drilled	T4895EO
X13	LY-MB810-81		25mm Extension profile cover cap		TR113AA

Ideal Standard International NV
Corporate Village – Gent Building
Da Vincilaan 2
B1935 – Zaventem
Belgium

BE +32 (02) 325 66 33
BG +359 675 30362
DE +49 (0)228 521 580
EG +202 26969700
FR +33 (0)1 49 38 28 00
GB 01482 496 318

GR +30 210 67 90 810
HR +38591 22 99 304
HU +36 30 6991 594
IT 800 652 290
ME +971 4 804 2400
NL +31 (077) 355 08 08

PL +48 71 7868 301/302
RO +40 21 3223 201/202
SI 00386 59 919040
TR +90 216 314 87 87
UA +359 675 30468
AL/XK/BA +359 887 709 696

CZ/SK +420 417 592 179
DK/NO/SE +45 75 84 10 10
ES/PT +34 93 561 80 00
LV/LT/EE +371 673 57 792
RS/MK/ME +381 11 713 80 58
RU/MD +7 495 669 23 11