

SPARE PARTS

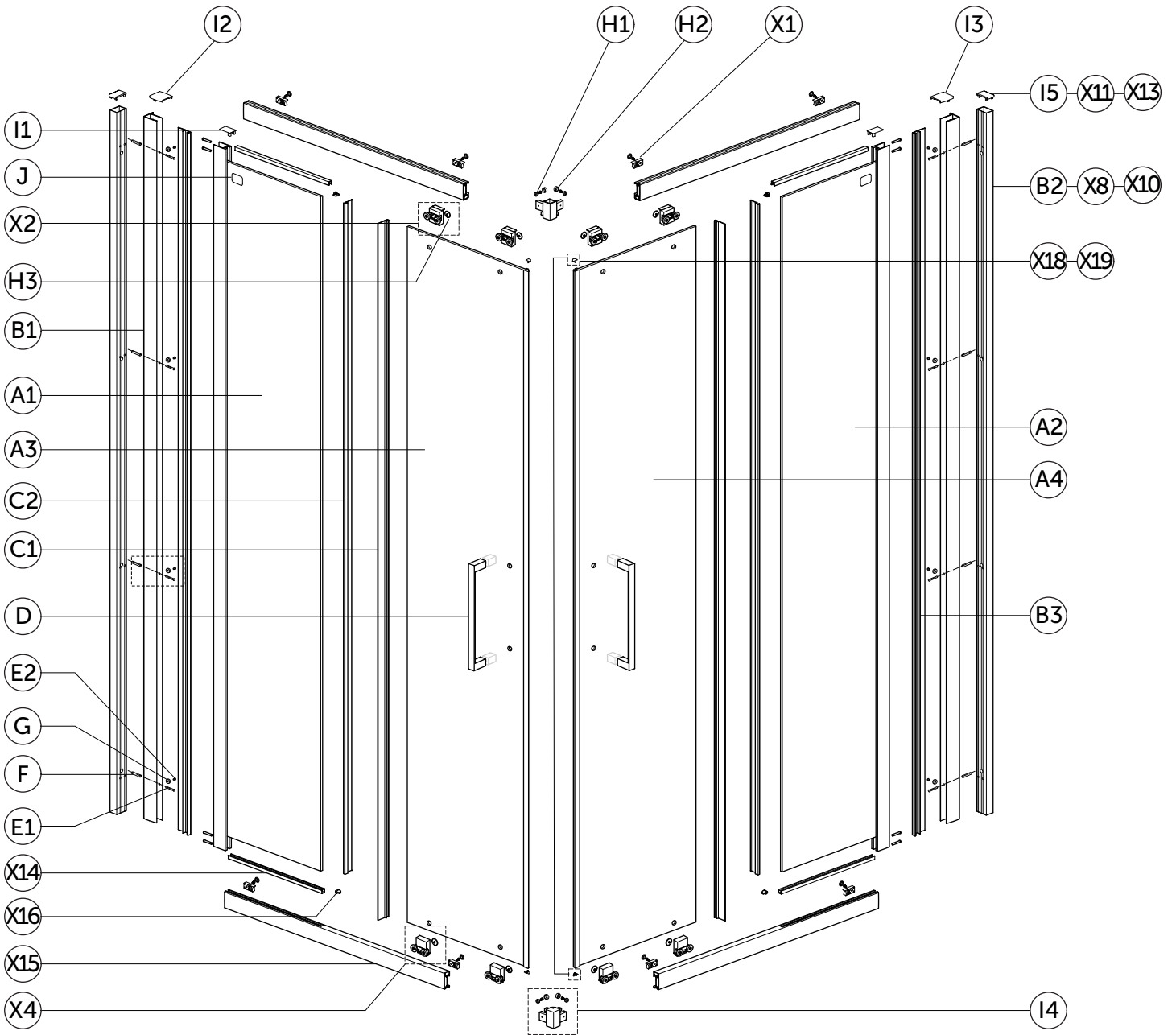







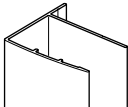
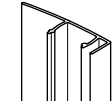
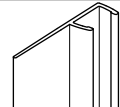
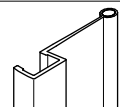

Corner Entry EU





I.LIFE

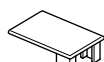
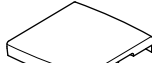
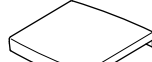
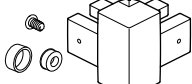

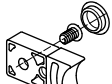

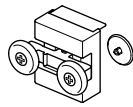
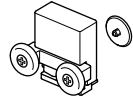
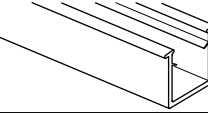
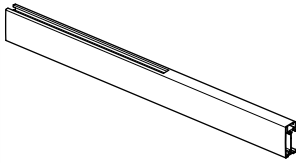

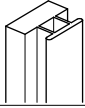
T4854	T4855	T4856	T4857	T4858	T4859	T4860
70	80	90	100	110	120	140

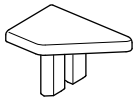

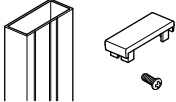
Item	ERP Code	Drawing	Description	Remark	SKU
A1 / A4			Fixed panel with vertical profile 70	Fixed Profile with profile	TR05467
			Fixed panel with vertical profile 80		TR05567
			Fixed panel with vertical profile 90		TR05667
			Fixed panel with vertical profile 100		TR05767
			Fixed panel with vertical profile 110		TR05867
			Fixed panel with vertical profile 120		TR05967
			Fixed panel with vertical profile 140		TR06067
A2 / A3			Sliding door with magnetic profile 70	Door with magnet profile without wheels	TR04767
			Sliding door with magnetic profile 80		TR04867
			Sliding door with magnetic profile 90		TR04967
			Sliding door with magnetic profile 100/110/120/140		TR05067

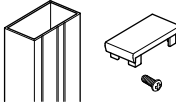
Item	ERP Code	Drawing	Description	Remark	SKU
B1	220659		Wall profile (EU - 20mm Adjustment)	1pc, length 2000mm, 8 holes pre-drilled	TR001EO
B3	220660		Wall cover profile (EU - 20mm Adjustment)	1pc, length 2000mm	TR005EO
C1	308-606		Vertical anti-water seal for 8mm door panel	1pc, length 1983mm	TR07167
C2	308-607		Vertical anti-water seal for 8mm fixed panel	1pc, length 1909mm	
D	LY-MB812-88		Single Handle - 380mm centres	complete set	TR099AA
E1			Installation pack fixing wall jamb on wall	TCB 3.9X30 : x8pcs	TR03667
E2				TCB 3.9X9 : x8pcs	
F				wall plug: x8pcs	
G		LY-JC200-10			
E1			Screws fixing vertical profile with rail profile	TCB 3.9X30 : x8pcs	TR03767
H3	LY-MB810-05		Flush Cover Cap for Wheel Assemblies	1pc	TR108AA
I1	LY-MB810-90		cover for vertical profile (EU - 20mm Adjustment)		TR105AA
I2	LY-MB810-91L		Top cover for wall profile LH (EU - 20mm Adjustment)		TR106AA
I3	LY-MB810-91R		Top cover for wall profile RH (EU - 20mm Adjustment)		TR107AA
I4 H1 H2 E2	LY-MB810-85		Connector with screw pack	TCB 3.9X8 : x2pcs screw white ring : x2pcs screw chrome cap : x2pcs connector: x1pc	TR118AA
J K			S.S. sticker with positioning template	x1 complete set	KV29567
X1			Door Stop	complete set including mounting screw	TR066AH

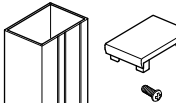
Item	ERP Code	Drawing	Description	Remark	SKU
X2	LY-MB810-07		Roller / Top - STANDARD	complete set (screw, covers, etc..)	TR125AA
X4	LY-MB810-13		Roller /Bottom	complete set (screw, covers, etc..)	TR126AA
X14	308-605		U shape anti-water seal (for 8mm glass)	1pc, length 850mm	TR07267
X15	220646		Horizontal profile for 70 (pair)	holes pre-drilled	TR015EO
			Horizontal profile for 80 (pair)		TR016EO
			Horizontal profile for 90 (pair)		TR017EO
			Horizontal profile for 100 (pair)		TR018EO
			Horizontal profile for 110 (pair)		TR019EO
			Horizontal profile for 120 (pair)		TR020EO
X16	LY-MB810-80		Slot cover (pair)	2pc in a pair	TR109AA
X17	LY-MB615-20		Magnetic sealer	magnet sealer 1983mm: x1pc	TR062AH
X18	LY-9694-02		Magnetic sealer profile end caps (pair)	sealer send cap Top : x1pc sealer send cap Bottom : x1pc	TR117AA
X19	LY9694-03				

X8	2258003; LY-JC310-51		15mm Extension profile, cover cap and x8 ST4x10 screws	holes pre-drilled	T4893EO
X11	LY-JC310-51		15mm Extension profile cover cap		TR111AA
B2	220651; LY-MB810-82		20mm Extension profile, cover cap and x8 ST4x10 screws	holes pre-drilled	T4894EO
I5	LY-MB810-82		20mm Extension profile cover cap		TR112AA
X10	220650; LY-MB810-81		25mm Extension profile, cover cap and x8 ST4x10 screws	holes pre-drilled	T4895EO
X13	LY-MB810-81		25mm Extension profile cover cap		TR113AA

Ideal Standard International NV
Corporate Village – Gent Building
Da Vincilaan 2
B1935 – Zaventem
Belgium

BE +32 (02) 325 66 33
BG +359 675 30362
DE +49 (0)228 521 580
EG +202 26969700
FR +33 (0)1 49 38 28 00
GB 01482 496 318

GR +30 210 67 90 810
HR +38591 22 99 304
HU +36 30 6991 594
IT 800 652 290
ME +971 4 804 2400
NL +31 (077) 355 08 08

PL +48 71 7868 301/302
RO +40 21 3223 201/202
SI 00386 59 919040
TR +90 216 314 87 87
UA +359 675 30468
AL/XK/BA +359 887 709 696

CZ/SK +420 417 592 179
DK/NO/SE +45 75 84 10 10
ES/PT +34 93 561 80 00
LV/LT/EE +371 673 57 792
RS/MK/ME +381 11 713 80 58
RU/MD +7 495 669 23 11