

SPARE PARTS

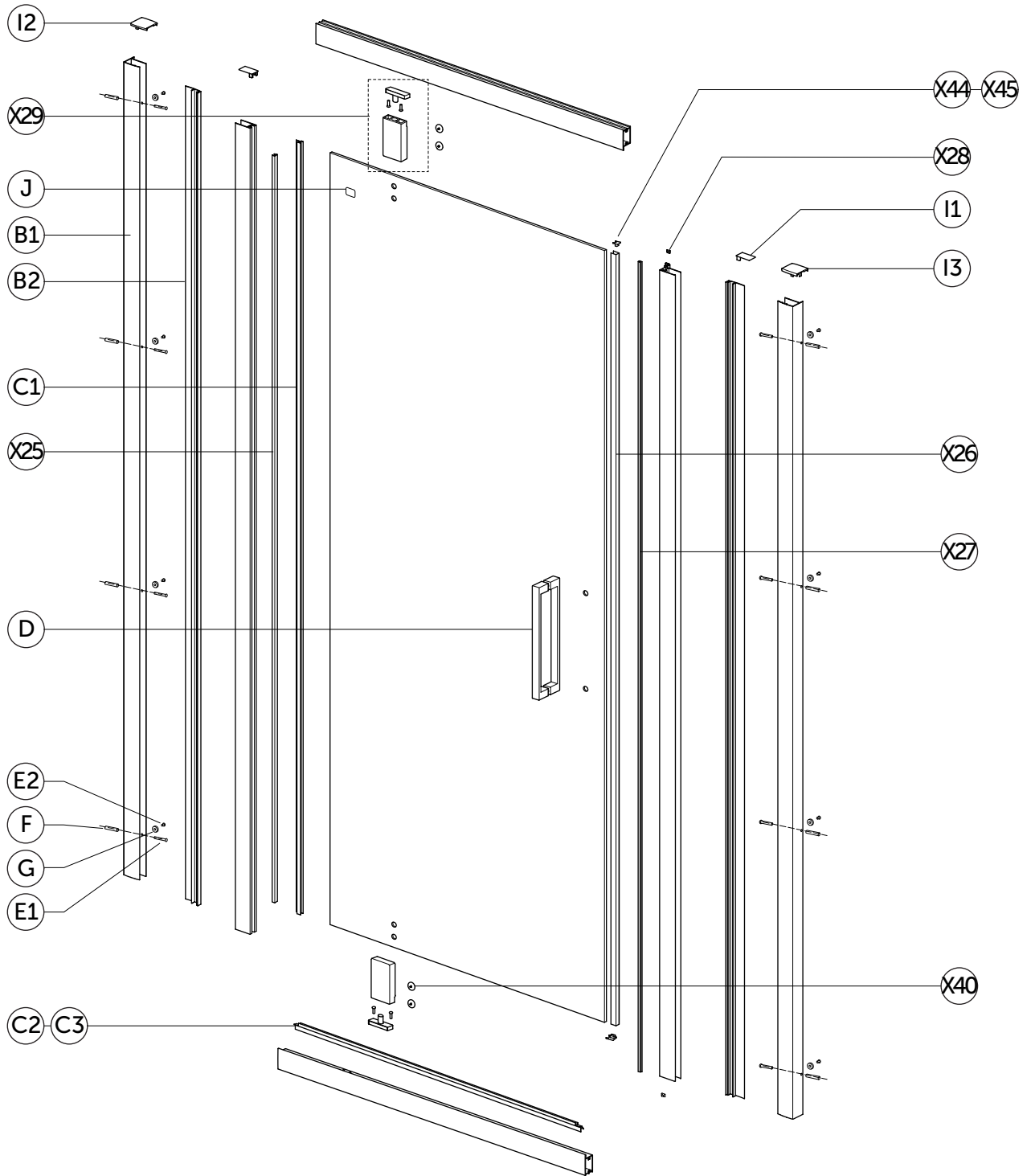





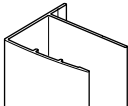
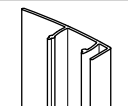

Pivot EU

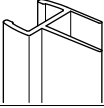
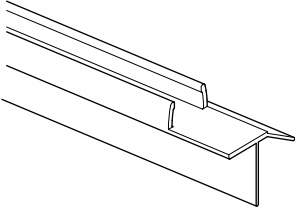

I.LIFE



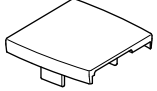
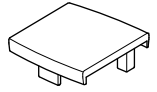

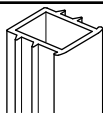
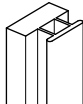
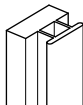
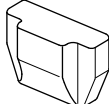
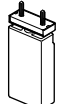

T4835	T4836	T4837	T4838	T4839	T4840	T4841
70	75	80	85	90	95	100

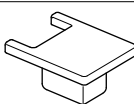
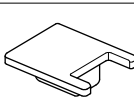

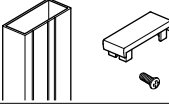
Item	ERP Code	Drawing	Description	Remark	SKU
B1	220659		Wall profile for Slider (EU - 20mm Adjustment)	length 2000mm, with 8 holes pre-drilled	TR001EO
B2	220660		Wall cover profile (EU - 20mm Adjustment)	length 2000mm	TR005EO

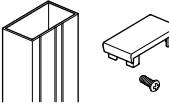
Item	ERP Code	Drawing	Description	Remark	SKU
C1	308-608		Vertical anti-water seal	length 1899mm	TR07567
C2 C3	308-621		Bottom Flap seal 700 - EU (Pair)	with 14mm & 12mm notch on each end LH & RH Seal length 590mm	TR07667
	308-621		Bottom Flap seal 750 - EU (Pair)	with 14mm & 12mm notch on each end LH & RH Seal length 640mm	TR07767
	308-621		Bottom Flap seal 800 - EU (Pair)	with 14mm & 12mm notch on each end LH & RH Seal length 690mm	TR07867
	308-621		Bottom Flap seal 850 - EU (Pair)	with 14mm & 12mm notch on each end LH & RH Seal length 740mm	TR07967
	308-621		Bottom Flap seal 900 - EU (Pair)	with 14mm & 12mm notch on each end LH & RH Seal length 790mm	TR08067
	308-621		Bottom Flap seal 950 - EU (Pair)	with 14mm & 12mm notch on each end LH & RH Seal length 840mm	TR08167
	308-621		Bottom Flap seal 1000 - EU (Pair)	with 14mm & 12mm notch on each end LH & RH Seal length 890mm	TR08267
D	LY-MB810-116		Double Handle - 380mm centres	complete set	TR098AA
E1			Installation pack fixing wall jamb on wall	TCB 3.9X30 : x8pcs	TR03667
E2				TCB 3.9X9 : x8pcs	
F				wall plug: x8pcs	
G				cover profile clip moulding : x8pcs	
I1	LY-MB810-90		cover for vertical profile (EU - 20mm Adjustment)	cover for vertical profile (EU - 20mm Adjustment)	TR105AA
I2	LY-MB810-91L		Top cover for wall profile LH (EU - 20mm Adjustment)	Top cover for wall profile LH x1	TR106AA
I3	LY-MB810-91R		Top cover for wall profile RH (EU - 20mm Adjustment)	Top cover for wall profile RH x1	TR107AA
J			S.S. sticker with positioning template		KV29567

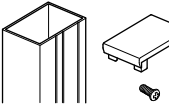
Item	ERP Code	Drawing	Description	Remark	SKU
X25	308-609		Filling sealer	length 1929mm	TR064AH
X26	LY-MB615-20		Magnetic sealer	magnet sealer 1896mm: x1pc	TR065AH
X27	LY-MB615-20		Pivot Frame Magnet Seal	magnet sealer 1990mm: x1pc	TR03467
X28	LY-MB615-13		Stopper for the magnetic seal on fixing profile side (pair)		TR069AH
X29			Pivot with covers and installation screws		TR128AA
X40	LY-MB815-07		Flush Cover Cap for Hinges & Pivots		TR159AA
X44	LY-MB810-83		Magnetic seal 2 top covers (pair)		TR120AA
X45	LY-MB810-83		Magnetic seal 2 top covers (pair)		

X8	2258003; LY-JC310-51		15mm Extension profile, cover cap and x8 ST4x10 screws	holes pre-drilled	T4893EO
X11	LY-JC310-51		15mm Extension profile cover cap		TR111AA
X9	220651; LY-MB810-82		20mm Extension profile, cover cap and x8 ST4x10 screws	holes pre-drilled	T4894EO
X12	LY-MB810-82		20mm Extension profile cover cap		TR112AA
X10	220650; LY-MB810-81		25mm Extension profile, cover cap and x8 ST4x10 screws	holes pre-drilled	T4895EO
X13	LY-MB810-81		25mm Extension profile cover cap		TR113AA

Ideal Standard International NV
Corporate Village – Gent Building
Da Vincilaan 2
B1935 – Zaventem
Belgium

BE +32 (0)2 325 66 33
BG +359 675 30362
DE +49 (0)228 521 580
EG +202 26969700
FR +33 (0)1 49 38 28 00
GB 01482 496 318

GR +30 210 67 90 810
HR +38591 22 99 304
HU +36 30 6991 594
IT 800 652 290
ME +971 4 804 2400
NL +31 (0)77 355 08 08

PL +48 71 7868 301/302
RO +40 21 3223 201/202
SI 00386 59 919040
TR +90 216 314 87 87
UA +359 675 30468
AL/XK/BA +359 887 709 696

CZ/SK +420 417 592 179
DK/NO/SE +45 75 84 10 10
ES/PT +34 93 561 80 00
LV/LT/EE +371 673 57 792
RS/MK/ME +381 11 713 80 58
RU/MD +7 495 669 23 11