

Produced since: **Nov. 2019**

Pre-installation kit 1

**A1313NU**

Spout lenght 180 mm

**A7378..**

Spout lenght 225 mm

**A7379..**

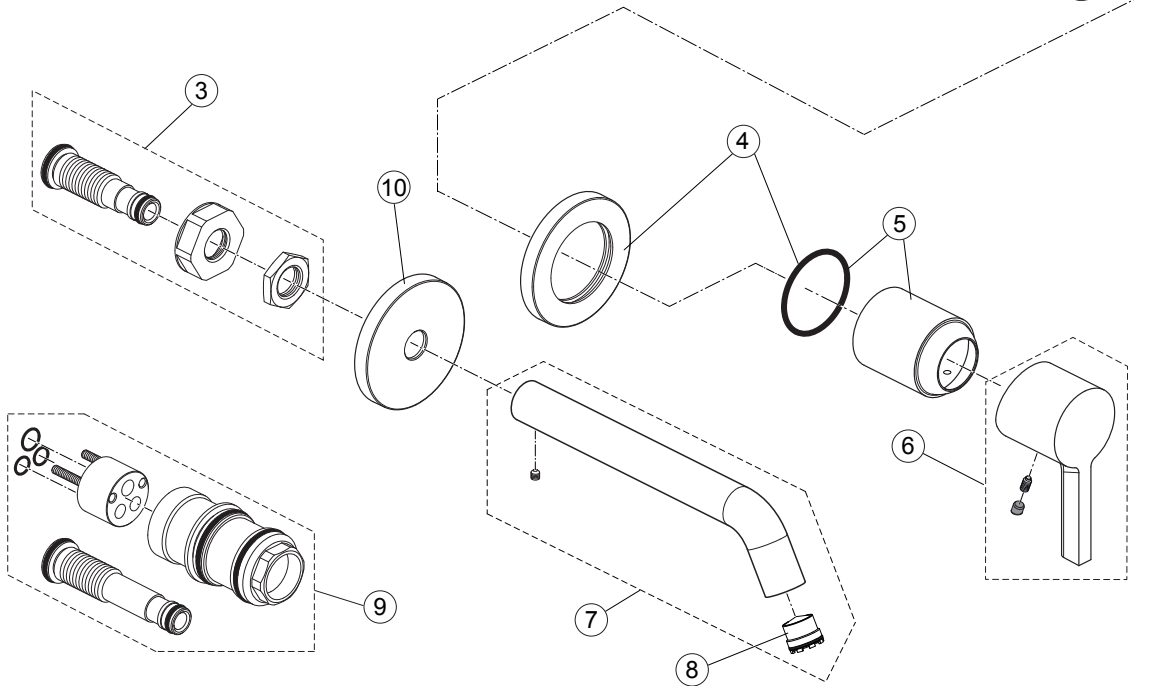
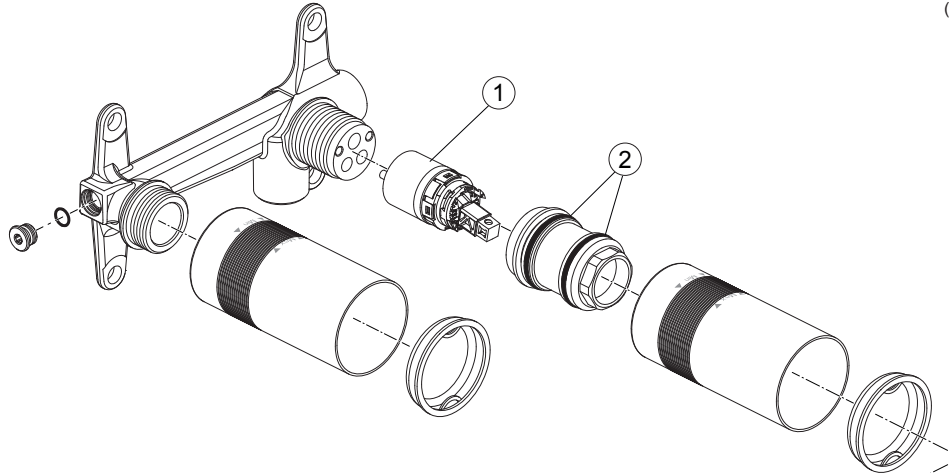
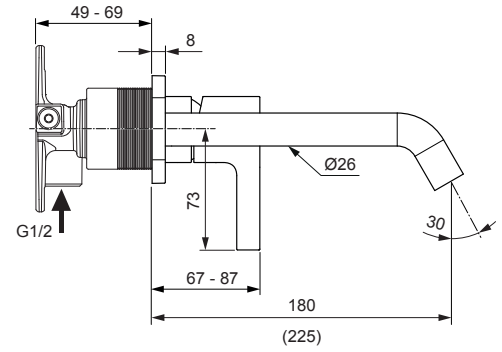
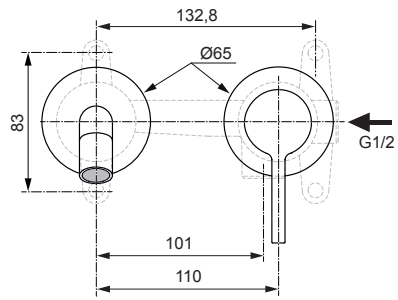

**Replace XX with the appropriate finish code**

Chrome = AA Silver Storm = GN Gold = A2 Magnetic Grey = A5

**Example spare part order:**

**A 861 430 AA** in Chrome

Pos.	Description	Part-Number	Qty.	Pos.	Description	Part-Number	Qty.
1	Cartridge Ø28 + O - ring	<b>A 861 397 NU*</b>	1 Set	10	Escutcheon with ISI-Logo	<b>A 861 434 XX</b>	1 pcs
2	O - Ring Ø 32 x 2	<b>A 9617 93 NU</b>	2 pcs	*Universal set (not all parts needed)			
3	Connector nipple cpl.	<b>A 861 422 NU</b>	1 Set				
4	Escutcheon with O-ring	<b>A 861 433 XX</b>	1 Set				
5	Cover cap with O-ring	<b>A 861 424 XX</b>	1 Set				
6	Lever cpl.	<b>A 861 429 XX</b>	1 Set				
7	Spout cpl. 180mm	<b>A 861 431 XX</b>	1 Set				
	Spout cpl. 225mm	<b>A 861 432 XX</b>	1 Set				
8	Aerator M16,5x1 - 5ltr/min	<b>A 962 708 NU</b>	1 pcs				
9	Extension kit 20mm longer	<b>A 861 428 NU</b>	1 Set				